

M40 – MOBILE CONCRETE BOOM PUMP

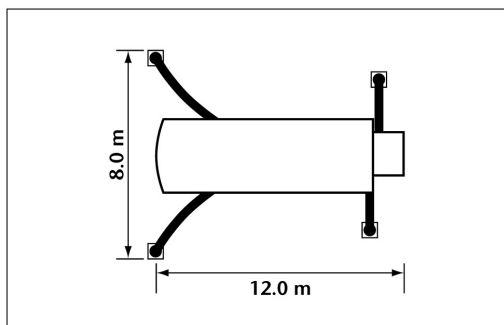
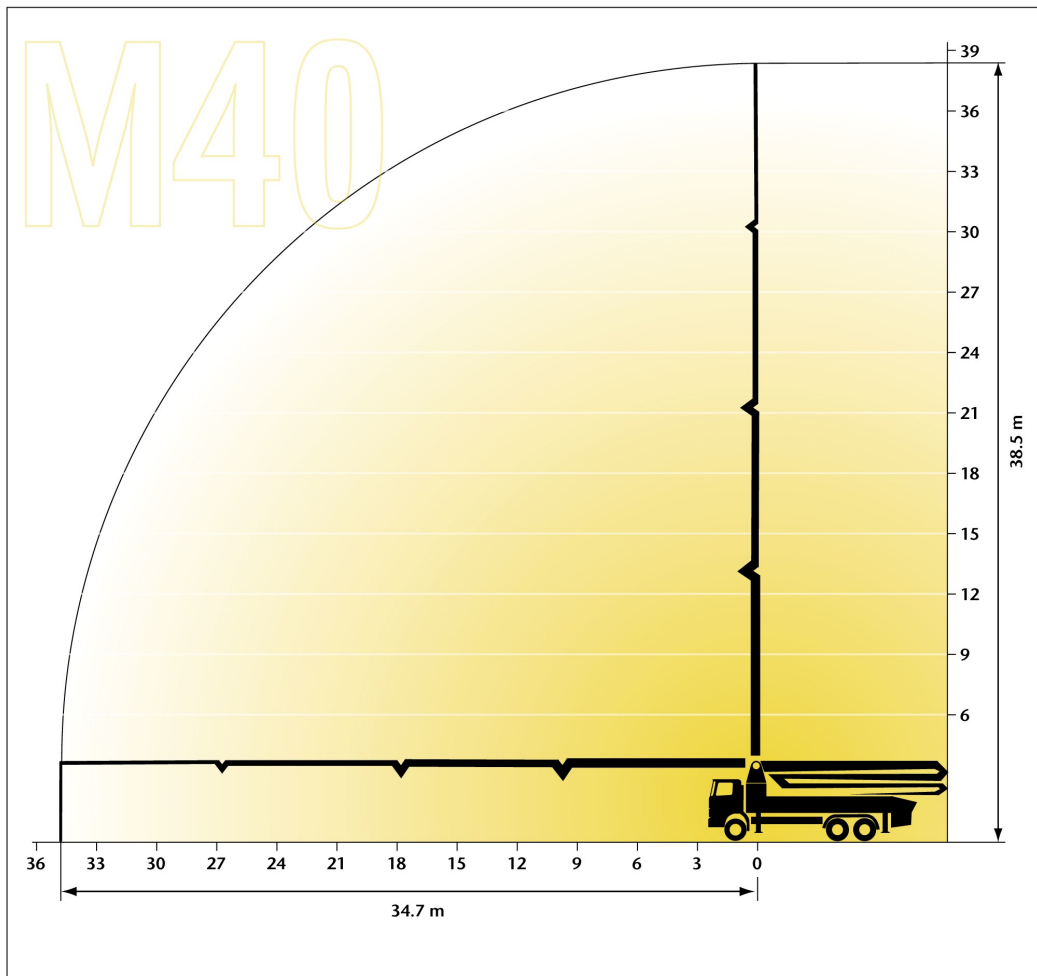

M40 – Mobile Concrete Boom Pump

BOOM	M40
Maximum vertical reach	38.5 m
Maximum gross horizontal reach	34.7 m
Maximum net horizontal reach	32.0 m
Reach depth	26.3 m
Minimum unfolding height	9.4 m
Number of arms	4
Pipeline diameter	125 mm
Pump length	12.0 m
Front outrigger spread	8.0 m (with OSS 5.2 m)
Rear outrigger spread	6.4 m (with OSS 4.4 m)

This information is given for guidance only. Due to fleet renewals and pump manufacturers' developments, the pumps supplied may differ slightly from specification outlined above. It is recommended that a site visit is requested if the exact pump dimensions are critical to the pumping operation.