

M16 – MOBILE CONCRETE BOOM PUMP

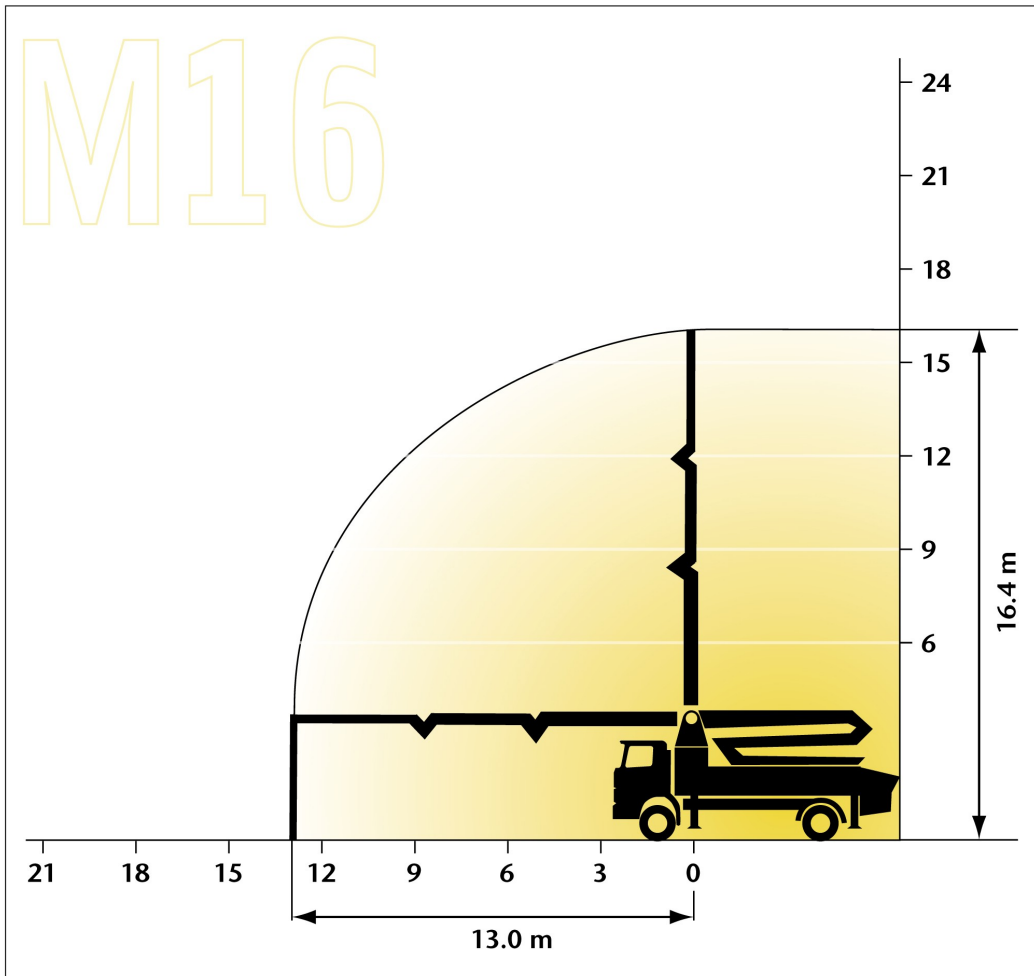

BOOM	M16
Maximum vertical reach	16.4 m
Maximum gross horizontal reach	13.0 m
Maximum net horizontal reach	10.5 m
Reach depth	8.1 m
Minimum unfolding height	4.1 m
Number of arms	3
Pipeline diameter	100 mm
Pump length	7.5 m
Front outrigger spread	2.3 m
Rear outrigger spread	2.3 m

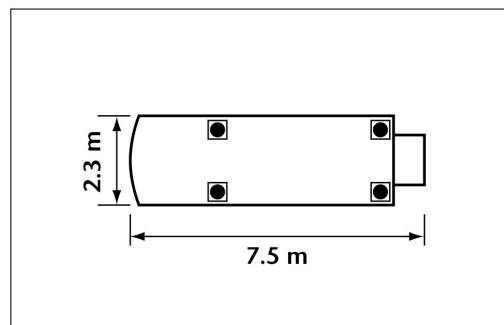

M16 – Mobile Concrete Boom Pump

This information is given for guidance only. Due to fleet renewals and pump manufacturers' developments, the pumps supplied may differ slightly from specification outlined above. It is recommended that a site visit is requested if the exact pump dimensions are critical to the pumping operation.